



FILTERMIST

Part of Absolent Air Care Group



FX SERIES

S SERIES

Local Exhaust Ventilation Manual & Log Book

**(Principles, Installation, Maintenance and
Testing of Filtermist LEV Systems)**

Company:

Unit Model No:

Unit Serial No:

Models

S200 : S400 : S800 : FX4002 : FX5002 : FX6002 : FX7002



Definition

“LEV (Local Exhaust Ventilation) is an engineering control system to reduce exposures to airborne contaminants such as dust, mist, fume, vapour, or gas in a workplace” (HSE 2011).

Statutory Examination and Testing

Every LEV system requires statutory thorough examination and testing by a competent person under the Control of Substances Hazardous to Health (COSHH) Regulations: 2002 (amended 2004). The maximum time between tests of LEV systems is 14 months. In practice this is normally taken to mean annually.

The examiner should:

- Carry out a thorough external examination of all parts of the system for damage, wear and tear.
- Measure the air velocities at suitable test points indicated in the system documentation.
- Measure static pressure at suitable test points indicated in the system documentation.
- Observe processes and sources and assess how effective the LEV is at controlling operators' exposure.

When testing hoods, the examiner will attach a test label to each hood tested. A red 'fail' label could be attached for the following reasons:

- No airflow.
- Failure of the hood to intercept or contain the contaminant cloud.
- The hood capture zone does not encompass the working zone.

The examiner will compare the test information against the original commissioning report, or previous test reports, to determine system effectiveness. A full report for each LEV system will be produced by the examiner. If required, the LEV report will highlight any minor adjustments or repairs required to make the LEV system effective.

Filtermist Limited is able to provide LEV testing to HSG258 standards. For a quotation, contact the Filtermist Sales Department on 01952 290500.



Filtermist as an LEV System

Filtermist units are designed for the control of aerosol mists, namely those generated by machining operations that use either soluble or neat oil coolants. Other applications include component washing machines and EDM machines. Due to the aggressive nature of the fluid, it is recommended that only stainless-steel versions are used on component washing machine applications.

Filtermist units are NOT designed to work on welding fume or dry dust applications. Please contact the Filtermist Technical Support Department (01952 290500) if further advice is required regarding the suitability of any application.

Filtermist units are designed for use with the majority of machine tools, both enclosed and open, and offer high levels of filtration with minimal service requirements. Enclosed machines are covered by changing the air within the enclosure between 6 and 10 times per minute, depending on application, whilst ensuring gaps within the enclosure are kept under a negative pressure. Open machines are usually covered by hoods positioned to capture and extract mists generated by the machining process.

Generally a capture velocity between 30 – 45 m/min is needed at the source of the contaminant. Typical installations are described later in this manual. Bespoke installations are also available.

Operation

Filtermist units are specifically designed to separate aerosol particles, usually oil mist, from the air, including oil and coolant mist and steam generated in parts washing process. A perforated steel drum, open at one end, is directly driven by a 3-phase electric motor. Four vanes within the drum generate suction which draws aerosols into the drum. Here the aerosols are impacted by the vanes at velocities in excess of 50 metres per second. The aerosol particles are forced to collide and coalesce before being driven by centrifugal force against the inner surface of the units casing. A drainage point ensures that the liquid is drained away under pressure. Cleaned air is returned to the workshop.

Four pads are fitted between the drum vanes to minimise noise levels and prevent the possibility of liquid fragmentation. As the drum speed is constant, the separation phase of the process remains constant ensuring high levels of filtration are maintained.

Efficiency

Aerosol particles are generally considered to be in the 0.2 – 5.0 micron range. Within this range are particles which provide a potential hazard to health. Particles above 3.5 micron are usually filtered out by the natural filters in the human system. Particles of 0.3 micron and below are thought to be exhaled.

This leaves an important range of particles that can be retained within the body and which should be removed from the air before they are inhaled

Filtermist units provide high filtration efficiencies across this critical range. Efficiencies of 98% have been shown in independent tests carried out on typical oil mist applications.

Greater efficiencies can be achieved using a high-efficiency secondary filter (afterfilter) on the exhaust side of the unit. UK customers have an afterfilter supplied as additional standard equipment along with each unit (excluding those units to be used on parts washing machines).

Installation

A Filtermist unit is normally sited either on (e.g. Fig.1) or close to the application, mounted on a stand (e.g. Fig.2) and therefore installation is straightforward requiring minimal ductwork. Filtermist units are light, require minimal floor space and can be installed in a wide variety of ways. A comprehensive library of existing installations is held by the company and can be used to demonstrate typical installations on most machine tools and applications.

The following are typical installations and cover the majority of applications. For more advice on these or other installation methods please contact your local supplier.

Always try to position the extraction point as far as practically possible from the cutting area of the machine and so that mist is drawn away from the operator's working area. On installation always take into account access and space requirements for service and maintenance of the unit, including consideration of local health and safety regulations. For ease of access, where possible, the unit should be positioned between 1040mm and 1370mm above the working level (providing the efficiency of the unit isn't compromised).



Fig.1

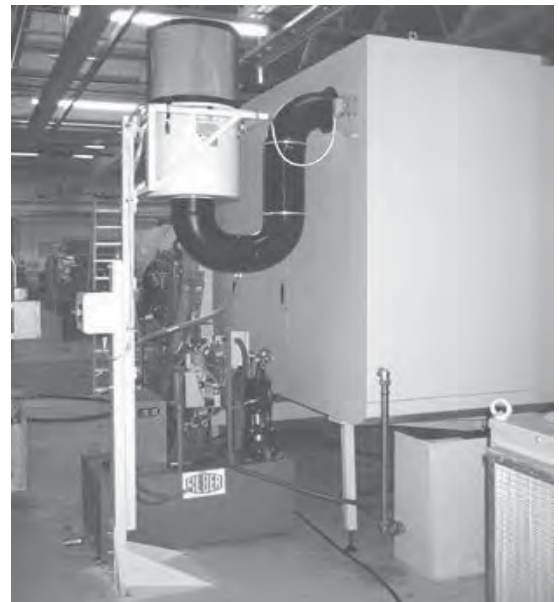

Fig.2

Please note that units intended for use in countries outside Britain may require changes to the motor settings. Please contact Filtermist Limited (01952 290500) for advice and technical support.

To ensure the continued performance of your Filtermist system, there is an integrated log book that the operator must complete. The forms included in this book should be used to record these checks, together with comments on any corrective action. Also a section for regular maintenance and unplanned repair work should be completed and is included in the log book. Any failure that is found should be reported to the person responsible for the maintenance of the system. The log book can be found from page 21 in this manual. It is important that these records are kept up to date to provide evidence that the system is following the HSE guidelines and that it is operating correctly.



Safety Information



Isolation from any power supply shall either be visible (visible break in the power supply circuits) or the isolation device is actuated to the off position and physically locked off.

2. The unit must not be operated without the case fitted.
3. At least 120 seconds must be allowed for the inner drum to stop rotating before the case is removed.
4. Oil leaks can be a hazard. The complete Filtermist system should be checked regularly for possible oil leaks. Daily visual checks of both unit and extraction duct are recommended.
5. Contact with oils, coolants etc. can cause skin disorders. Avoid contact with skin and eyes and wear PVC, neo prene or nitrile gloves, safety glasses and overalls when cleaning or working on the filter.
6. The unit to be used on wet applications only, e.g. Oil, emulsion, coolant or steam.
7. The unit is not to be used on flammable, explosive, corrosive or dry applications, e.g dust, smoke, acid.
8. The unit is intended for indoor use only.

Daily visual checks of both unit and extraction duct are recommended.

Ensure that the recommended schedules of checks, as detailed in the accompanying Log Book, are followed.

General Information

Filtermist units remove and separate contaminants by centrifugal impaction, forcing aerosols to coalesce into larger droplets and removing them from the airstream. High levels of filtration and constant efficiency make this method of separation ideal for machining applications using coolants.

Recovered oil can be returned to the machine tool or a separate container, whilst the cleaned air is exhausted back into the work area. Collection of contaminated air should be as close as possible to its source so installation of a Filtermist unit will usually be directly on, or very close to, the machine tool, simplifying any installation requirements.

Filtermist unit are available in a comprehensive range of air volumes suitable for a wide range of machine tools.

Some simple guidelines need to be followed to ensure trouble free installation of each unit.

- On enclosed machine applications, the extraction point should be positioned as far as practically possible from the cutting area of the machine. This will prevent oil droplets being drawn up into the unit and possibly overloading the unit. It will also prevent swarf being drawn into the inlet grille which over time will cause a reduction in air flow and therefore extraction.
- The extraction point should also be positioned so that mist is drawn away from the operators working area.

Installation Information



Ducting runs should be as short as possible (e.g. Fig.3). U-bends should be avoided as these will encourage oil to collect, reduce airflow and become an area for potential leaks. Where U-bends are unavoidable, suitable drainage points should be provided (e.g. Fig.4).



Fig.3

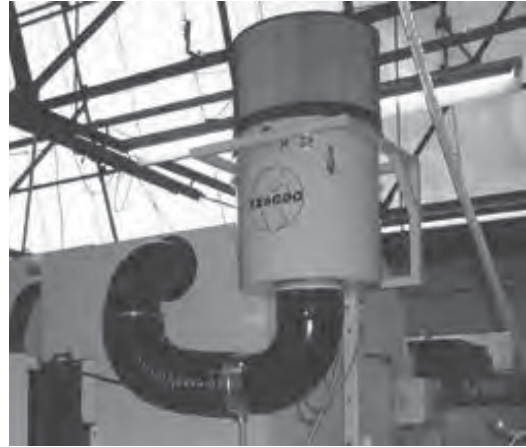

Fig.4

- The oil return tube from the Filtermist unit should be straight with smooth bends – no kinks - and unrestricted (e.g. Fig.5). The end of the tube must not be submerged as this will prevent oil from the unit being discharged.



Fig.5

- Fishtail hoods should be in a fixed position so as to ensure that mist produced during the process is drawn away from the point of generation and into the hood. In some cases, more than one fishtail hood will be required (e.g. Fig.6).



Fig.6



The following are typical installations and cover the majority of applications. For more advice on these or other installation methods please contact (01952 290500).

Always try to position the extraction point as far as practically possible from the cutting area of the machine and so that mist is drawn away from the operator's working area.

Direct Mount To Machine Tool - Vertical

WARNING! Always ensure that the machine can support the weight of the unit (see table 1 on page 12)



(1) Remove 4 x insert screws in base of unit.



(2) Fit 4 x case studs (supplied with unit).



(3) Fit foam collar seal around inlet spigot (supplied with unit).



(4) Cut extraction hole in machine enclosure.

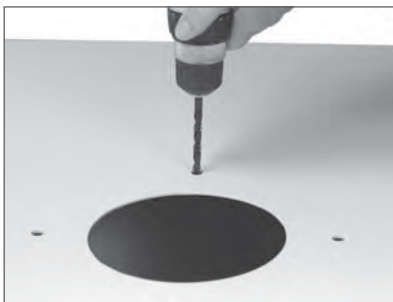

(5) Drill 4 x case stud fixing holes (see table on page 12 for hole size and case stud hole PCD).



(6) Cut hole for oil return tube (if required).

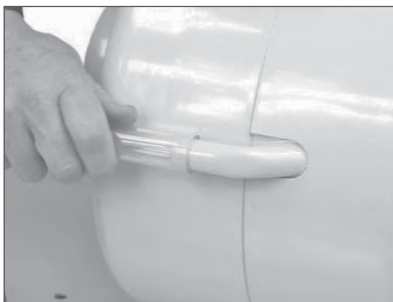

(7) Fit oil return tube and position tube to drain oil back to machine enclosure, sump or collection vessel.



(8) Position unit and secure.

IMPORTANT! There must be no kinks or 'U' bends in the return tube. The end of the tube must not be submerged.



Floor Stand Mount (S Series only.)



(1) Fit case studs as for Direct Mount.

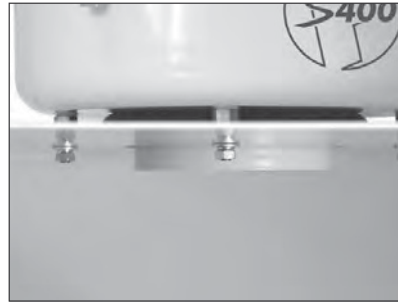

(2) Fit unit to stand (supplied separately) and secure.

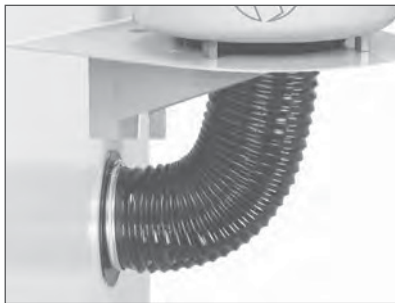

(3) Connect inlet of unit to extraction hole using suitable duct and adaptor (supplied separately).



(4) Fit oil return tube and position tube to drain oil back to machine enclosure, sump or collection vessel.

IMPORTANT! There must be no kinks or 'U' bends in the return tube. The end of the tube must not be submerged.



(5) Secure stand to floor with floor bolts.



Floor Stand Mount (FX Series only.)



(1) Remove 4 x insert screws in top of unit at 90° intervals.



(2) Screw in 4 x eyebolts with nylon washers.



(3) Tighten eyebolts until horizontal.



(4) Fit safety nuts on eyebolt threads inside of unit.



(5) Position unit in stand and secure unit with bolts (supplied with unit).



(6) Connect inlet of unit to extraction hole using suitable duct and adaptor (supplied separately).



(7) Fit oil return tube and position tube to drain oil back to machine enclosure, sump or collection vessel.



(8) Secure stand to floor with floor bolts.

IMPORTANT! There must be no kinks or 'U' bends in the return tube. The end of the tube must not be submerged.



Airflow Indicator

HSE guidelines recommend that Airflow Indicators are fitted to provide the machine operator with a visual indication that the extraction system is operating effectively. Please contact the Filtermist Sales Department (01952 290500) for details of this optional equipment. The F Monitor 2 is a monitoring device that measures airflow and time to indicate when the Filtermist unit needs servicing. An additional sensor can be fitted to also monitor temperature and vibration. It uses a traffic light system of coloured LED lights to show the operating status of the unit and can be set to suit particular applications. The monitor is supplied with additional output source should an extra indicator be required.





Electrical Connection

Filtermist FX series and S Series motors are wound for low & high voltage and operate on 50Hz & 60Hz as shown in the table below. A connection diagram can be found inside the motor terminal box.

NOTE: Motor terminal connections will be configured for the motor to run at High voltage unless Low voltage connection is specified at the time of ordering.

The motors must be connected via a 3-phase, direct-on-line starter and isolator with suitable thermal overloads or via an independent supply in the machine control panel.

On start-up the motor will draw current in excess of that shown on the motor plate. Ensure that appropriate fuses are used.

IMPORTANT! The unit must run in the direction indicated by the arrow on the upper section and must run continuously. To change rotation, swap any two supply wires. It must not be wired to switch on and off with the machine cycle.

Recommended overload settings and terminal connection. Overloads to be set no higher than 125% of the motors full load current.

Low Voltage Settings

LOW VOLTAGE		recommended overload settings				
		200v		220v		230v
		50hz	60hz	50hz	60hz	60hz
0.18kw	FLC	1.02	1.02	1.02	1.02	1.02
0.55kw	FLC	2.7	2.6	2.7	2.6	2.6
1.1kw	FLC	4.4	4.6	4.4	4.6	4.6
1.5kw	FLC	6.3	6.3	6.3	6.3	6.3
2.2kw	FLC	8.8	NA	8.8	9.4	9.4

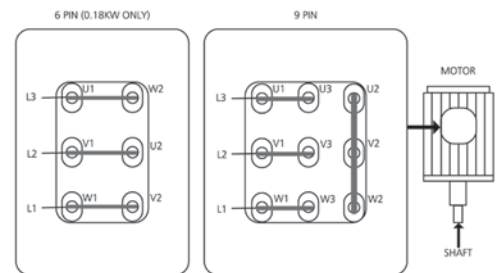

IMPORTANT! Please note that for 230/240v, 50HZ applications, special motors are required. For more information, contact your supplier

High Voltage Settings

HIGH VOLTAGE		recommended overload settings				
		380v	400v	440v	460v	480v
		50hz	50hz	60hz	60hz	60hz
0.18kw	FLC	0.59	0.59	0.59	0.59	0.59
0.55kw	FLC	1.35	1.35	1.3	1.3	1.3
1.1kw	FLC	2.2	2.2	2.3	2.3	2.3
1.5kw	FLC	3.15	3.15	3.15	3.15	3.15
2.2kw*	FLC	4.4	4.4	4.7	4.7	4.7

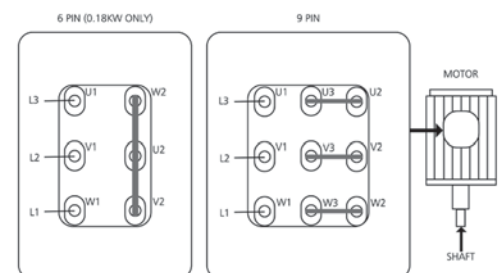

IMPORTANT! FX7002 must only be used with 50HZ supply. **Do not use on 60HZ APPLICATIONS**



	S200	S400	S800	FX4002	FX5002	FX6002	FX7002
Airflow - M/hr	180 @ 50Hz; 215 @ 60Hz	425 @ 50Hz; 500 @ 60Hz	800 @ 50Hz; 950 @ 60Hz	1250 @ 50Hz; 1500 @ 60Hz	1675 @ 50Hz; 2000 @ 60Hz	2000 @ 50Hz; 2400 @ 60Hz	2750 @ 50Hz
Motor (IE3)	0.18Kw	0.55kw	0.55kw	1.1Kw	1.5Kw	2.2Kw	2.2Kw
Weight (kg)	8	14	15	23	27.5	37	37
Noise (dBa)	62	65	67	70	71	73	73
Construction	MILD STEEL, POWDER COATED GREY RAL7035						
Extraction Hole Diameter	80mm	155mm	155mm	155mm	205mm	205mm	205mm
Case Stud Hole PCD (mm)	190	250	250	275	275	275	275
Case Stud Hole Diameter(mm)	10	10	10	10	10	10	10
Drain Tube Diameter	19mm	19mm	19mm	19mm	19mm	19mm	19mm
Inlet Spigot Diameter	73mm	148mm	148mm	148mm	198mm	198mm	198mm
Direct Mounting	Yes	Yes	Yes	Yes	Yes	Yes	Yes
Stand Mounting	No	Yes	Yes	Yes	Yes	Yes	Yes
Mounting Centres	N/A	As for case studs	As for case studs	4 eyebolts - 398mm PCD	4 eyebolts - 398mm PCD	4 eyebolts - 485mm PCD	4 eyebolts - 485mm PCD
Inlet velocity - m/sec	10	6.5	12	19	14	17	24



Maintenance

Filtermist can provide a full service and maintenance package to ensure that your Filtermist unit is working to its optimum efficiency. Please contact the office (Tel: 01952 290500)

Should you wish to carry out maintenance yourself then always ensure you use genuine Filtermist spares. Guidelines on how to carry out maintenance are shown below.

Maintenance should be carried out in accordance with the following guidelines.

Failure to carry out maintenance could result in insufficient extraction from the machine and a deterioration of efficiency. Certain applications, e.g. grinding or cast iron machining, should be checked and maintained on a more regular basis, according to duty.

As well as scheduled maintenance requirements, daily, weekly and monthly checks are also recommended. These are listed in the log book provided with each unit. Additional copies can be requested by contacting our office.

Maintenance requirements are covered by two schedules:-

- 1000-hour Service - Parts required for the 1000 hour service are provided in a Filter Kit – see page 18 & 19
- 2000-hour Service - Parts required for the 2000 hour service are provided in a Service Kit – see page 18 & 19

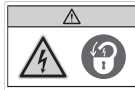

Isolator

If requested, the unit may be supplied with an isolator switch complete with motor protection overload. The overload starter is changeable to suit different sized units or voltage. Contact Filtermist for more details (Tel 01952 290500). If not requested, the motors must be connected via a direct – on – line starter and isolator with suitable thermal overloads or via an independent supply from control panel. Machine must be provided with a clearly identified, readily accessible electrical isolation point providing all-pole disconnection which has the facility for lock-off (e.g. between 0.60 and 1.7m above the working surface).

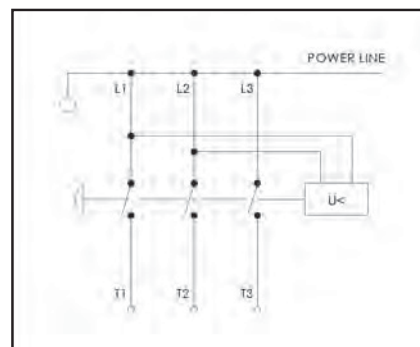



Every 1000 Hours Running Time (use Filter Kit 4; see page 18 & 19)

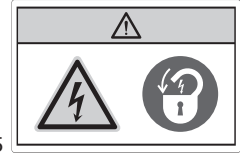

please refer to page 5



(1) Undo safety latch and clips.



(2) Separate top and bottom of case.



(3) Remove old seal.



(4) Clean area where top and bottom of case join & clean drain hole.

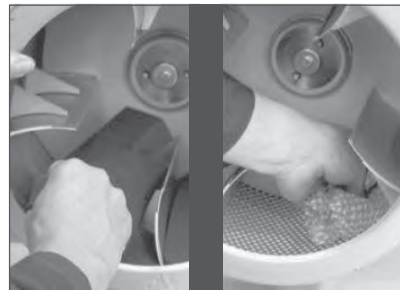

(5) Remove old drum pads, clean inside of drum and inspect drum for signs of damage.
IMPORTANT! Damaged drums should be replaced.



(6) Fit new drum pads.



(7) Fit new seal.

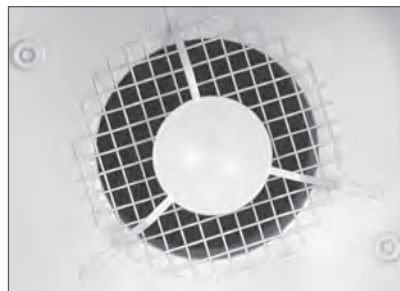

(8) Check inlet grille is clear.



(9) Re-assemble unit.
IMPORTANT! Ensure safety latch and clip are securely fastened.



(1) Undo safety latch and clips.



(2) Separate top and bottom of case.



(3) Remove old seal.



(4) Clean area where top and bottom of case join & clean drain hole.

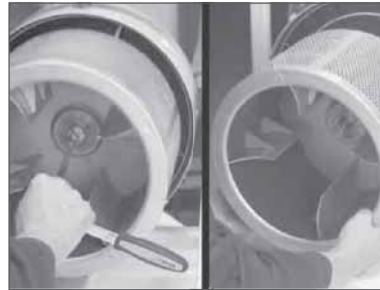

(5) Remove drum.

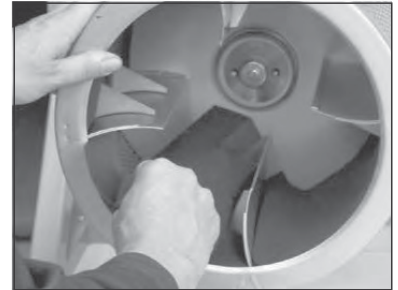

(6) Remove old drum pads.



(7) Clean inside and outside of drum.



(8) Fit new drum pads.

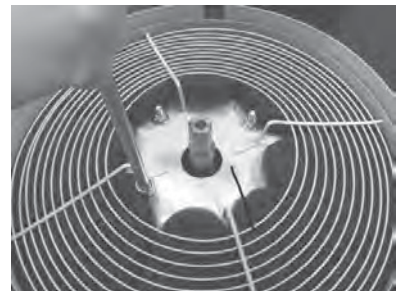

(9) Remove motor mounting nuts.



(10) Withdraw motor from housing.



(11) Remove old motor mounts and replace with new mounts. Tighten mounts to 8Nm.



(12) Remove old silencer & fit new silencer.



Every 2000 Hours Running Time (continued)

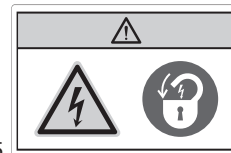

please refer to page 5



(13) Re-fit motor to top of case.

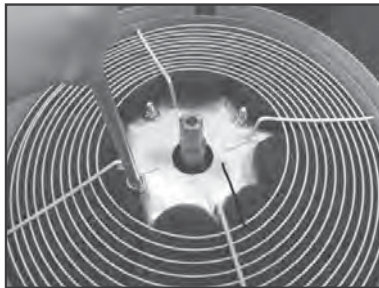

(14) **IMPORTANT!** Fit new motor mounting nuts & tighten (5Nm S Series or 8Nm FX Series).

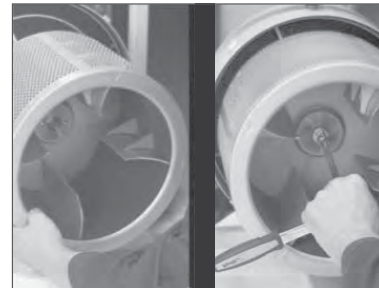

(15) Ensure bush (if your unit has one), shaft and drum hub are clean and free from debris before re-fitting the drum. If your unit includes a drum bush, tighten to 20Nm, if it includes taper collar(s), tighten bolt to 8Nm.

IMPORTANT! Check that taper collars are fitted correctly before tightening the bolts

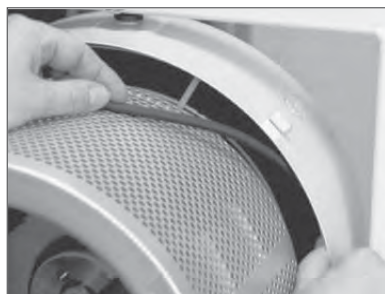

(16) Fit new seal.

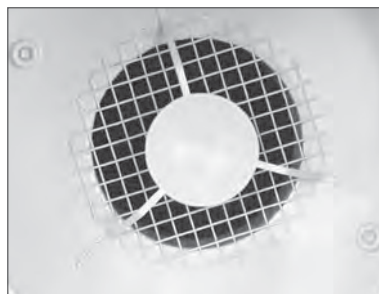

(17) Check inlet grille is clear.



(18] Re-assemble unit.

IMPORTANT! Ensure safety latch and clip are securely fastened.



Additional maintenance checks for all service intervals

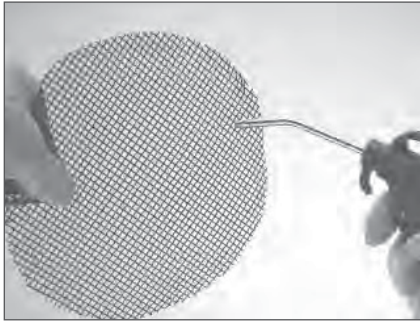

(1) Clean the swarf arrester (where fitted).

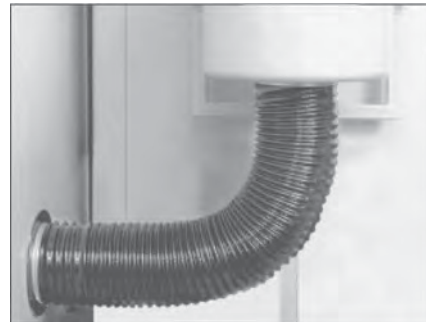

(2) Check any ducting for damage or blockage.



(3) Check oil return hose for damage or blockage.



(4) Check afterfilter (if fitted) and replace as necessary.

Important Note

In more arduous conditions e.g. grinding or cast iron machining; the units should be checked and cleaned on a more frequent basis, according to duty.

Contact your FILTERMIST supplier for details of maintenance plans and spares kits.

IMPORTANT!

Use only genuine Filtermist spares – Use of unauthorised parts may affect performance adversely and invalidate the warranty.

In addition to 1000 and 2000 hour checks

- Check condition of any ductwork ensuring all connections are tight
- Check cleanliness of any grilles in the system and ensure that fishtail hoods (if fitted) are clean.
- Check air flow indicators (if fitted) are operating correctly and connections to the ductwork are clean and clear.

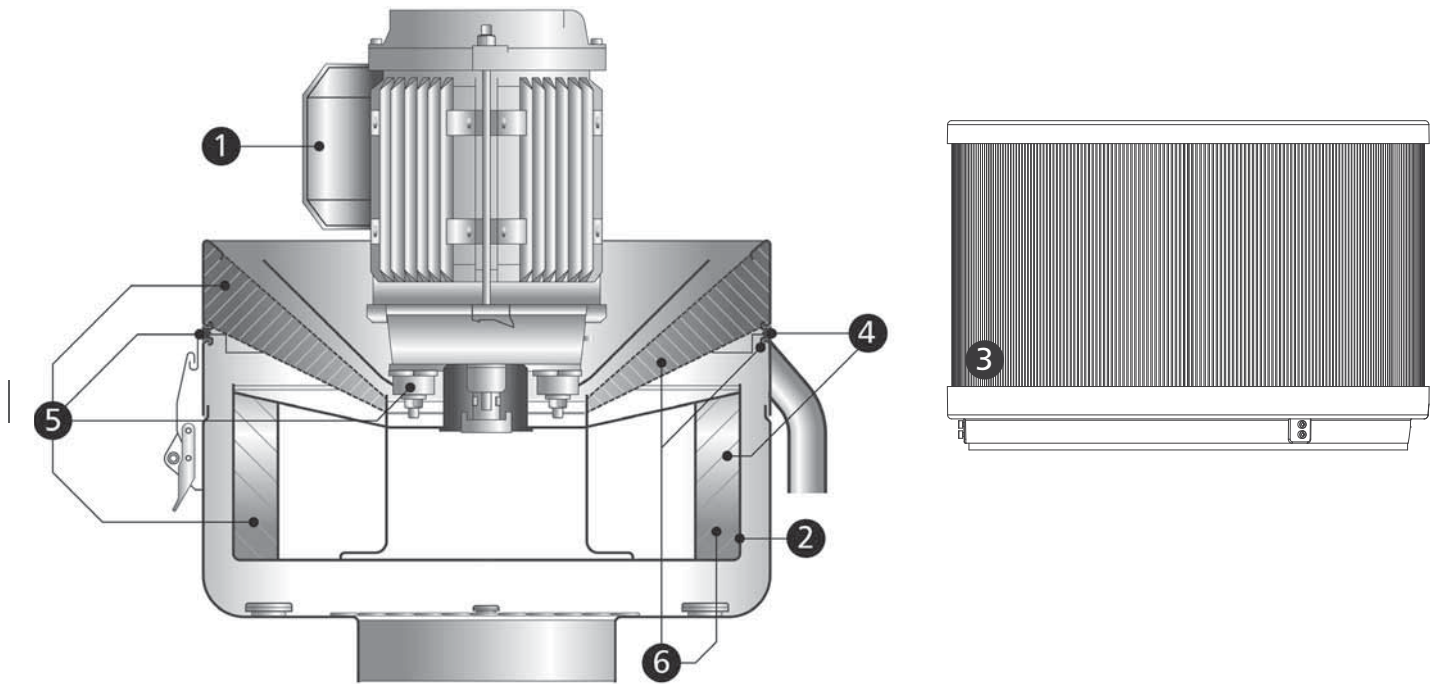

Number	Item	Model	Part number
1	Motor	S200 S400 S800	20-213-30-052 20-213-30-161 20-213-30-161
2	Drum	S200 S400 S800	20-213-30-020 20-213-30-021 20-213-30-022
3	Afterfilter (92% efficiency) High-Efficiency Afterfilter (99.95% efficiency)	S200 S400 S800 S200 S400 S800	20-206-10-000 20-206-10-003 20-206-10-003 No HE Afterfilter for the S200 20-206-10-006 20-206-10-006
4 For 1000 hour service	Filter Kit	S200 S400 S800	20-213-30-050 20-213-30-046 20-213-30-051
5 For 2000 hour service	Spares Kit	S400 S800	20-213-30-094 20-213-30-095
6 For 2000 hour service	Spares Kit	S200	20-213-30-093

Spares Information

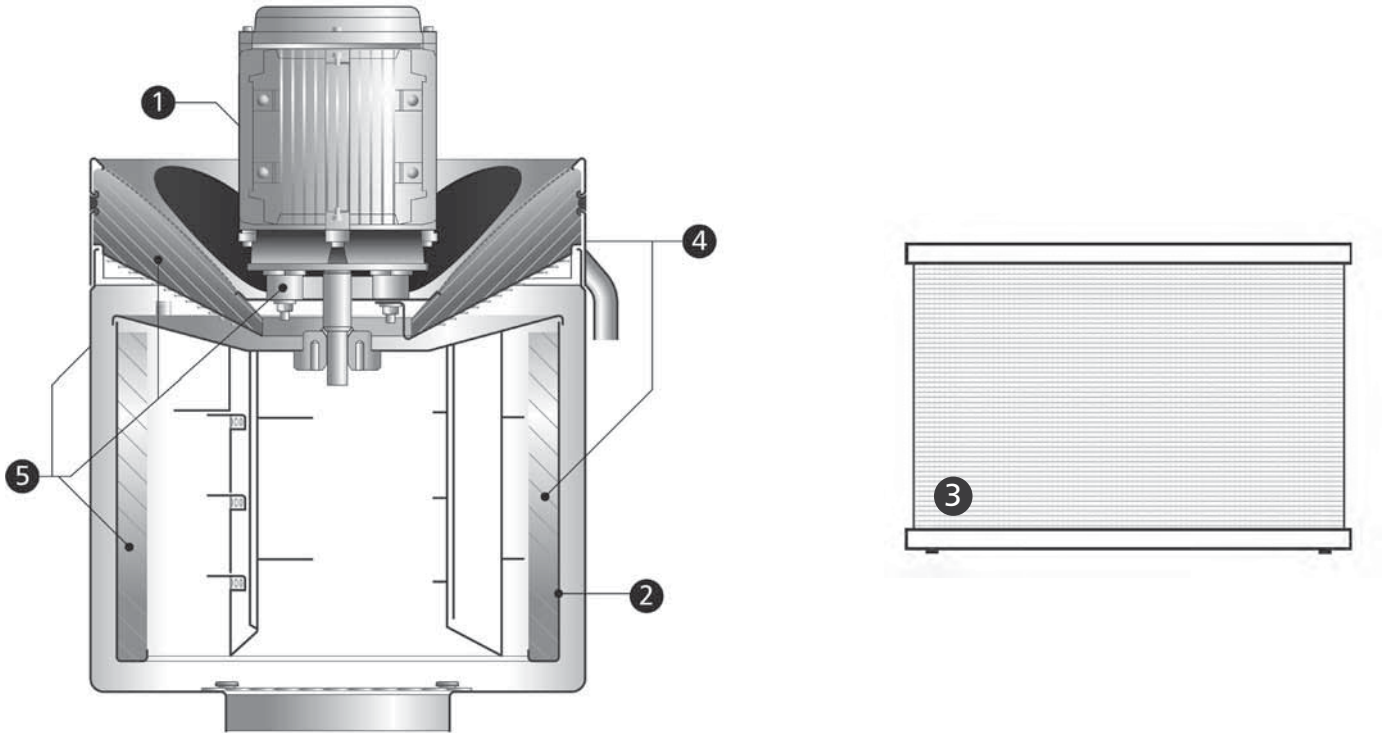

Number	Item	Model	Part number
1	Motor	FX4002 FX5002 FX6002/FX7002	20-213-30-162 20-213-30-163 20-213-30-164
2	Drum	FX4002 FX5002 FX6002 FX7002	20-213-30-015 20-213-30-017 20-213-30-013 20-213-30-019
3	Afterfilter (92% efficiency) High-Efficiency Afterfilter (99.95% efficiency)	FX4/5002 FX6/7002 FX4/5002 FX6/7002	20-206-10-002 20-206-10-001 20-206-10-005 20-206-10-004
4 For 1000 hour service	Filter Kit	FX4002 FX5002 FX6/7002	20-213-30-047 20-213-30-048 20-213-30-049
5 For 2000 hour service	Spares Kit	FX4002 FX5002 FX6/7002	20-213-30-090 20-213-30-092 20-213-30-087



Problem	Possible Cause	Action
Unit vibrates or makes excessive noise	Drum has solids build-up Damaged motor bearing	Clean the drum, ensuring all solids are removed from sides and base of vanes and change filter pads Check motor bearing and replace motor if required
Unit continues to vibrate	Drum is out of balance	Return to Filtermist for re-balancing
Mist comes out of top of unit	Drum is rotating in wrong direction Drain hose is blocked, kinked or submerged Excessive extraction Mist could be oil smoke	Check rotation of drum – anti-clockwise when viewed from inlet Re-position and clean the drain hose Re-position extraction point or fit splashguard Fit afterfilter
Unit is not extracting	Blocked inlet Afterfilter is blocked Unit needs servicing	Clean inlet swarf arrestor Change afterfilter – (recommended every 3-6 months) See pages 13 – 17 for details.
Unit cuts out on start-up	Overload setting incorrect	Reset or replace overload (see electrical info chart).



FILTERMIST

Local Exhaust Ventilation

LOG BOOK





Schedule of Checks and Maintenance

To ensure the continued performance of your Filtermist system, the following daily, weekly and monthly checks should be carried out. The forms included in this book should be used to record these checks, together with comments on any corrective action required.

A separate section for regular maintenance and unplanned repair work is also included and should be completed as appropriate.

Any failure found should be reported to the person responsible for maintenance work.

Please refer to the Troubleshooting section of the LEV Manual for more information.

It is important these records are kept up to date as they will help ensure the system is operating correctly and provide evidence that HSE guidelines are being followed.

Daily Checks

- Check that the unit is turned on and operational.
- Once the unit is running, check the status of the airflow monitor (if fitted).

Weekly Checks

- Check all grilles and pre-filters within the extraction ductwork and ensure they are clear.
- Check that the machine enclosure is clearing.
- Check that the hoods (if applicable) are in the correct position to ensure that contaminants are being cleared from within the working zone.
- Check the position of airflow regulator controls. These will have been set and marked during the commissioning process.

Monthly Checks

- Check any interconnecting ductwork for any damage or leaks and check that all ductwork connections are secure.
- Check that the drain hose is unrestricted and not submerged. Empty the collection container if one is used.
- Check that any 'U' bend drain (if fitted) is functioning correctly. Follow similar checks for the drain hose.
- Check for excessive vibration or unusual noises from the Filtermist unit.
- Check the capture hoods (if fitted) for damage or blockage.
- Check the condition of afterfilter (if fitted).

All new Filtermist oil mist filters come with a **FREE**

5 YEAR WARRANTY*



- ✔ Protect your people for longer
- ✔ Less potential for downtime
- ✔ Added peace of mind
- ✔ No extra cost

Every single Filtermist unit undertakes rigorous Quality Assurance checks during the assembly process to ensure it meets our high quality standards and reaches you in perfect condition.

We are so confident of the build quality of our UK manufactured oil mist filters that we've introduced a 5-year warranty* on all new Filtermist units - totally FREE of charge.



Precision
engineered
in the UK

Visit www.filtermist.com to activate your **5-year warranty** and download the *terms & conditions

Bitte besuchen Sie www.filtermist.de um Ihre **5 Jahre Garantie** zu aktivieren und die Allgemeinen Geschäftsbedingungen herunterzuladen

Cortesemente visita il sito www.filtermist.it per attivare la tua **garanzia di 5 anni** e per scaricare termini e condizioni

请访问www.filtermist.cn以激活您的5年质保并下载相关条款

www.filtermist.jpで5年間保証を有効化し、“規約条件”をダウンロードして下さい。

Visite www.filtermist.es para activar su **garantía de 5 años** y descargar los * términos y condiciones



Interim Service
Date
Signed by
1000hrs

Full Service
Date
Signed by
2000hrs

Interim Service
Date
Signed by
1000hrs

Full Service
Date
Signed by
2000hrs

Interim Service
Date
Signed by
1000hrs

Full Service
Date
Signed by
2000hrs

Unscheduled Maintenance/Repair

Date	Reason for Maintenance	Parts Used	Fitted by	Comments

EC DECLARATION OF CONFORMITY



Manufacturer's name:		Filtermist Limited		Machinery covered by this declaration:	
Full address:	Filtermist Limited, Telford 54 Business Park, Nedge Hill, Telford, TF3 3AL, England	Description:	Oil Mist Filter		
		Function:	To be fitted to machinery to extract oil fumes		
		Type:	S & FX series supplied with isolator		
Authorised Representative:	Absolent AB		Model:	S200, S400, S800, FX4002, FX5002, FX6002, FX7002	
Full address:	Staplaregatan 1 SE-531 40 Lidköping Sweden		Serial No.:	See unit	
The machinery conforms to all the requirements of the Machinery Directive 2006/42/EC.					
The machinery also conforms to the following Directives:		EMC Directive 2014/30/EC RoHS Directive 2011/65/EU			
The following standards have been used:		EN12100:2010, EN 60204-1:2018, EN ISO 14120:2015, EN ISO 13857:2019			
The technical file is compiled in accordance with part A of Annex VII of the Machinery Directive 2006/42/EC.					
Person authorised to compile the technical file (based in the European Community):		Name:	Absolent AB		
		Address:	Staplaregatan 1 SE-531 40 Lidköping Sweden		
The relevant authorised person undertakes to transmit, in response to a reasoned request by the national authorities, relevant information on the machinery. This information will be transmitted by: (email, post)					
Person authorised to make this declaration:		Name:	Craig Haynes		
		Position in company:	Product Engineering Team Lead		
		Signature:			
		Place of Declaration:	Filtermist Limited, Telford 54 Business Park, Nedge Hill, Telford, TF3 3AL, England		
		Date of Declaration:	January 1st 2024		

UKCA DECLARATION OF CONFORMITY



Manufacturer's name:	Filtermist Limited	Machinery covered by this declaration:	
Full address:	Filtermist Limited, Telford 54 Business Park, Nedge Hill, Telford, TF3 3AL, England	Description:	Oil Mist Filter
		Function:	To be fitted to machinery to extract oil & coolant mist
		Type:	S & FX series
		Model:	S200, S400, S800, FX4002, FX5002, FX6002, FX7002
		Serial No.:	See unit
The machinery conforms to all the requirements of the Supply of Machinery (Safety) Regulations 2008			
The machinery also conforms to the following Directives:	Electromagnetic Compatibility Regulations 2016 The Restriction of the Use of Certain Hazardous Substances in Electrical and Electronic Equipment Regulations 2012		
The following standards have been used:	BS EN 12100:2010, BS EN 60204-1:2018, BS EN ISO 14120:2015, BS EN ISO 13857:2019		
The technical file is compiled in accordance with part A of Annex II of the Supply of Machinery (Safety) Regulations 2008.			
The relevant authorised person undertakes to transmit, in response to a reasoned request by the national authorities, relevant information on the machinery. This information will be transmitted by: (email, post)			
Person authorised to make this declaration:	Name:	Craig Haynes	
	Position in company:	Product Engineering Team Lead	
	Signature:		
	Place of Declaration:	Filtermist Limited, Telford 54 Business Park, Nedge Hill, Telford, TF3 3AL, England	
	Date of Declaration:	1st January 2024	

Supplied by:



Certificate Number 232
ISO 9001
ISO 14001



Part of Absolent
Air Care Group

Filtermist Limited
Telford 54 Business Park
Nedge Hill
Telford
Shropshire
TF3 3AL
England

Tel: +44 (0)1952 290500
Email: sales@filtermist.com
www.filtermist.com